



Product name:
Product number:

Double Ended SP2 Reaction Arm Blank
10026

REV: 09-2024

All dimensions are in Inches [Millimeters]

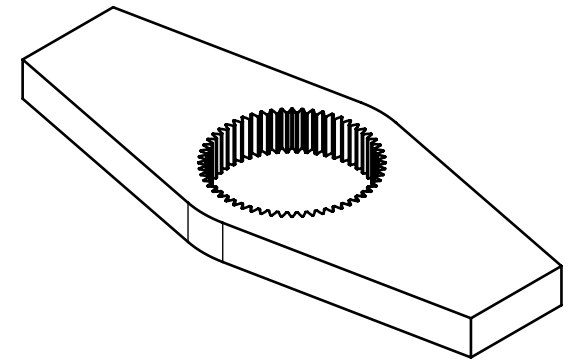
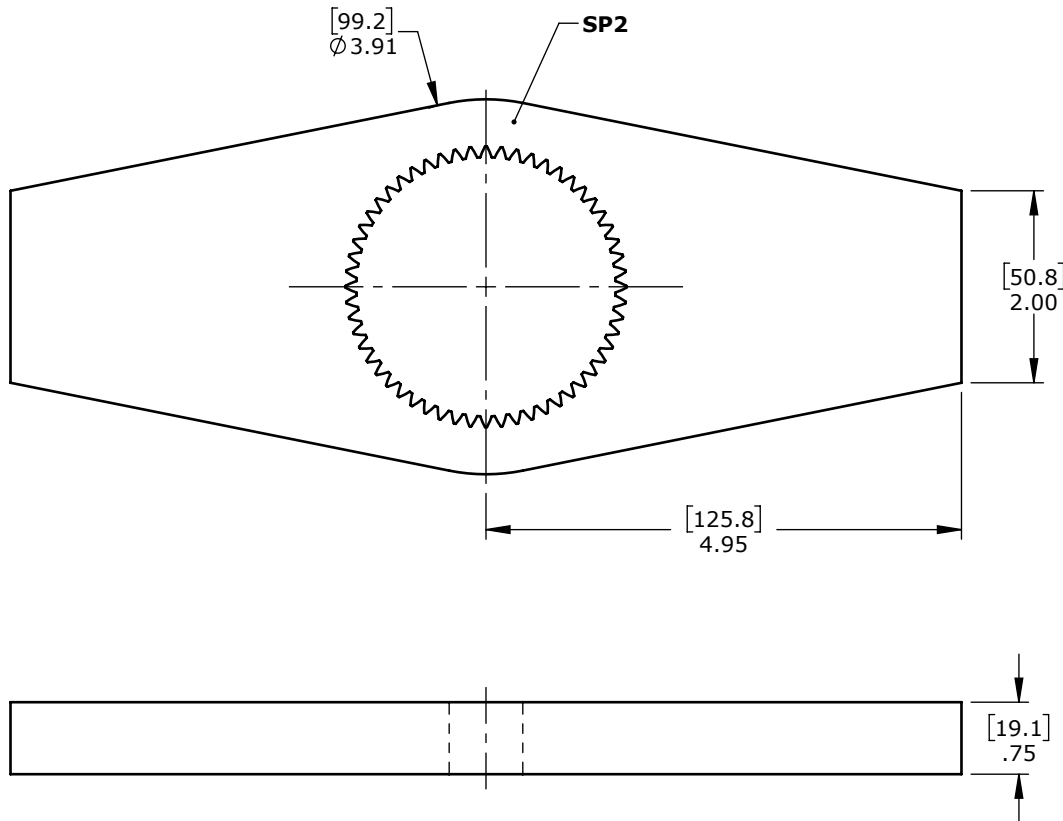

Suitable for: 30DX(Spline), 40DX-M(Spline), B-RAD 3000(Spline), B-RAD 4000-M(Spline)

DISCLAIMER: The data and illustrations in this document are accurate to the best of the company's knowledge. Information is subject to change without prior notice. For critical information, please verify its accuracy by contacting RAD Torque Systems. Unauthorized reproduction and distribution of this content are strictly prohibited.